

UNI-T®

**Model UT805
OPERATING MANUAL**



TABLE OF CONTENTS

TITLE	PAGE
Overview	3
Unpacking Inspection	4
Safety Information	5
Rules For Safe Operation	5
International Electrical Symbols	7
The Meter Structure	8
A. Front Panel	8
B. Rear Panel	10
Functional Buttons	11
Display Symbols	14
Measurement Operation	18
A. DC Voltage Measurement	18
B. AC Voltage Measurement	20
C. DC or AC Current Measurement	22
D. Measuring Resistance	24
E. Testing Diodes	27
F. Testing for Continuity	29
G. Capacitance Measurement	31
H. Frequency Measurement	33
Selecting a Measurement Range (∇, AUTO and Δ Button)	35
The Use of Relative Value Mode	36
MAX MIN Mode	37
The Use of STO and RCL Button	38
Operation of Hold Mode	39
General Specifications	39
Accuracy Specifications	41
A. DC Voltage	41

TITLE	PAGE
B. AC Voltage -----	42
C. DC Current -----	43
D. AC Current -----	44
E. Resistance -----	45
F. Diode Test -----	46
G. Continuity Test -----	46
H. Capacitance -----	47
I. Frequency -----	48
Calibration Procedure -----	49
A. DC Voltage -----	49
B. AC Voltage -----	50
C. DC Current -----	51
D. AC Current -----	51
E. Resistance -----	52
F. AC Voltage with DC deviation (AC+DC) -----	52
G. AC Current with DC deviation (AC+DC) -----	52
Summary of error codes -----	53
Maintenance -----	54
A. General Service -----	54
B. Replacing the Fuses -----	55
RS232C and USB Serial Port -----	57
System Requirements for Installing the UT805 Interface Program -----	57
RS232C Serial Port -----	58
A. Connecting between the Meter and computer -----	58
B. RS232C Port Cable -----	58
C. Setting of RS232C Serial Ports -----	58
USB Serial Port -----	61
A. Connecting between the Meter and computer -----	61
B. Setting of USB Serial Ports -----	61

Overview

This Operating Manual covers information on safety and cautions. Please read the relevant information carefully and observe all the Warnings and Notes strictly.



Warning

To avoid electric shock or personal injury, read the “Safety Information” and “Rules for Safety Operation” carefully before using the Meter.

Model **UT805** is a kind of 5 1/2 digit, vacuum-fluorescent, dual display bench-type true RMS Multimeter (hereafter referred to as “the Meter”). The Meter’s circuit design is the combination of large scale integrated simulation and digital circuit, taking microcomputer technology with 24 counts A/D converter as a core, highly precise amplifier, True RMS’s AC converter and full electronic calibration technique to make it as a reliable and accurate Multimeter.

In addition to all the conventional features including DC/AC voltage, current, resistance, diode, continuity test, capacitance, frequency, there is a recall function. RS232C and USB standard serial port for easy connection with computer to realize macro recording and monitoring and capture of transient dynamic data, displaying change of waveform during the measurement, providing data and evidence to engineering technicians for scientific research.

This is also a highly applied digital multimeter of good performance with full overload protection. This Meter uses AC power to make it becoming a better electrical equipment.

Unpacking Inspection

Carefully remove the Meter from its shipping container and check the following items carefully to see any missing or damaged part:

Item	Description	Qty
1	Operating Manual	1 piece
2	Test Lead	1 pair
3	Alligator Clip	1 pair
4	Multi-Purpose Socket	1 piece
5	Line Cord (AC220V~50Hz, 15W or AC110V~50Hz, 15W)	1 piece
6	RS232C Interface Cable	1 piece
7	USB Interface Cable	1 piece
8	Installation Guide & Computer Interface Software (CD-ROM)	1 piece

In the event you find any missing or damage, please contact your dealer immediately.

Safety Information

This Meter complies with the standards IEC61010: in pollution degree 2, overvoltage category (CAT. I 1000V, CAT II 600V) and double insulation.

CAT. III: Distribution level, fixed installation, with smaller transient overvoltage than CAT. IV.

CAT IV: Primary supply level, overhead lines, cable systems etc.

Use the Meter only as specified in this operating manual, otherwise the protection provided by the Meter may be impaired.

In this manual, a **Warning** identifies conditions and actions that pose hazards to the user, or may damage the Meter or the equipment under test.

A Note identifies the information that user should pay attention on.

International electrical symbols used on the Meter and in this Operating Manual are explained on page 7.

Rules For Safe Operation













Warning

To avoid possible electric shock or personal injury, and to avoid possible damage to the Meter or to the equipment under test, adhere to the following rules:

- I Before using the Meter inspect the case. Do not use the Meter if it is damaged or the case (or part of the case) is removed. Look for cracks or missing plastic. Pay attention to the insulation around the connectors.
- I Inspect the test leads and power cord for damaged insulation or exposed metal. Check the test leads for continuity. Replace damaged test leads and power cord with identical model number or electrical specifications before using the Meter.
- I Inspect the VFD display for no display..
- I Do not apply more than the rated voltage, as marked on the Meter, between the terminals or between any terminal and grounding.

- 1 Ensure the Meter is at right measurement position range. Disconnect the connection between the test lead and the circuit under tested before changing over the range. No changeover of range shall be made during measurement is conducted to prevent damage of the Meter.
- 1 When the Meter working at an effective voltage over 60V in DC or 30V in AC, special care should be taken for there is danger of electric shock.
- 1 Use the proper terminals, function, and range for your measurements.
- 1 Under the manual ranging mode, if the value to be measured is unknown, use the maximum measurement position and reduce the range step by step until a satisfactory reading is obtained.
- 1 Do not use or store the Meter in an environment of high temperature, humidity, explosive, inflammable and strong magnetic field. The performance of the Meter may deteriorate after dampened.
- 1 When using the test leads, keep your fingers behind the finger guards.
- 1 Disconnect circuit power and discharge all high-voltage capacitors before testing on-line resistance, continuity, diodes, current, or capacitance.
- 1 Before measuring current, check the Meter's fuses and turn off power to the circuit before connecting the Meter to the circuit.
- 1 Remove test leads, RS232C interface cable, USB interface cable and alligator clip from the Meter and turn the Meter power off before opening the Meter case.
- 1 When servicing the Meter, use only the same model number or identical electrical specifications replacement parts.
- 1 The internal circuit of the Meter shall not be altered at will to avoid damage of the Meter and any accident.
- 1 Soft cloth and mild detergent should be used to clean the surface of the Meter when servicing. No abrasive and solvent should be used to prevent the surface of the Meter from corrosion, damage and accident.
- 1 The Meter is suitable for indoor use.
- 1 Turn the Meter power off when it is not in use.

International Electrical Symbols

	AC or DC
	Grounding
	Double Insulated
	Warning. Refer to the Operating Manual
	High Voltage
	Continuity Test
	Diode
	Capacitance Test
	Fuse
	Conforms to Standards of European Union

The Meter Structure

A. Front Panel (see figure 1)

1. VFD Display
2. Primary Functional Buttons: Different key functions selection.
3. **COM** Input Terminal: Negative input terminal, inserting the black test lead.
4. **V/Ω** Input Terminal: Positive input terminal for voltage and resistance measurement, inserting the red test lead.
5. **200mA MAX** Input Terminal: Positive input terminal for mA measurement, inserting the red test lead.
6. **10A MAX** Input Terminal: Positive input terminal for A measurement, inserting the red test lead.
7. **Hz** Input Terminal: Positive input terminal for capacitance, frequency, diode and continuity measurement, inserting the red test lead.
8. **2mA** and **200mA** Buttons: mA and A measurement selection
9. **AC+DC** Button: The measurement of AC voltage or current with DC deviation.

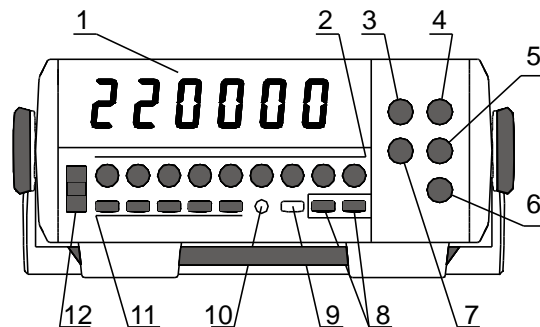

(figure 1)

Model UT805: OPERATING MANUAL

10. **CAL** Button: Calibrate the accuracy of Voltage, Current and Resistance
11. Secondary Functional Buttons: Different side functions selection.
12. **RANGE** Button (∇ , **AUTO** and \triangle): Select Auto or Manual ranging

B. Rear Panel (see figure 2)

1. HI Input Terminal:
| 4-wire configuration to measure resistance: high current terminal, inserting red test lead.
2. LO Input Terminal
| 4-wire configuration to measure resistance: low current terminal, inserting black test lead.
3. HI Input Terminal
| 4-wire configuration to measure resistance, high current terminal, inserting red test lead.
4. LO Input Terminal
| 4-wire configuration to measure resistance, low current terminal, inserting black test lead
5. Power: The on off switch of AC220V~50Hz, 15W or AC110V~50Hz, 15W power supplier. "I" means power up while "O" means power off.
6. Power-Line Cord Connector: Plug the AC220V ~50Hz,15W or AC110V~50Hz, 15W line cord
7. USB Interface Connector
8. RS232C Interface Connector

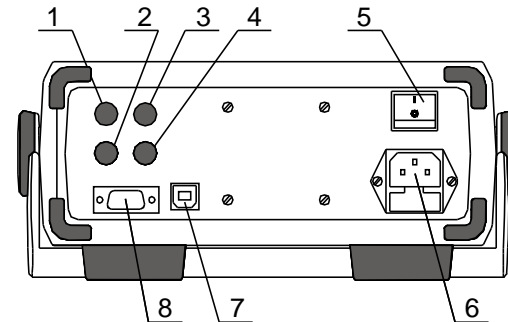



(figure 2)

Functional Buttons

The pushbuttons on the front panel select the Meter functions and operations. Below table indicated for information about the functional button operations.

Button	Operation Performed
▽, AUTO and △ Button)	Switching between auto and manual ranging, step through the ranges when the Meter is at manual ranging measurement mode.
•)	Continuity Test
→	Diode Test
Hz	Frequency Test
⎓	Capacitance Test
Ω	Resistance Measurement: 1 Press Ω to enter resistance measurement mode. Use the front input terminals for 2 wire measurement and the back input terminals for 4 wire measurement.
ACV	AC Voltage Measurement, displaying True RMS value
DCV	DC Voltage Measurement
ACI	AC Current Measurement, displaying True RMS value



Button	Operation Performed
DCI	AC Current Measurement
2mA & 200mA	<ul style="list-style-type: none"> 1 Press 2mA down to select 2mA current measurement range. 1 Press 200mA down to select 200mA current measurement range. 1 Press both 2mA and 200mA down is a mis-operation, the Meter displays "--Err 1-". 1 When both 2mA and 200mA are not pressed down, 10A range is default when measuring current.
AC+DC	<p>It is used to measure AC Voltage or Current with DC deviation:</p> <ul style="list-style-type: none"> 1 It can only be used at AC Voltage or AC Current measurement mode otherwise the Meter displays "--Err1-", then back to the previous measurement range.
CAL	<p>It is a calibration button:</p> <ul style="list-style-type: none"> 1 Press it to calibrate ACV, DCV, ACI, DCI, ACV and DCV with DC deviation, and resistance. Details refer to page 52 of this operating manual.
REL Δ	<p>Press REL Δ to enter and exit REL mode.:</p> <p>Press MAX MIN to select the maximum and minimum value.</p>

Button	Operation Performed
MAX MIN	Press MAX MIN to select the maximum and minimum value.
STO and RCL	<ul style="list-style-type: none"> 1 Press STO to store the reading. 1 Press RCL to recall the stored reading.
HOLD	<p>HOLD has two features:</p> <ul style="list-style-type: none"> 1. Data Holding <ul style="list-style-type: none"> 1 Press HOLD to enter Hold mode, the VFD display  1 Press HOLD again to exit Hold mode, the  disappear. 2. Exit STO, RCL and MAX MIN mode. <ul style="list-style-type: none"> 1 Press HOLD to exit STO, RCL and MAX MIN mode when the Meter is at STO, RCL and MAX MIN measurement mode.

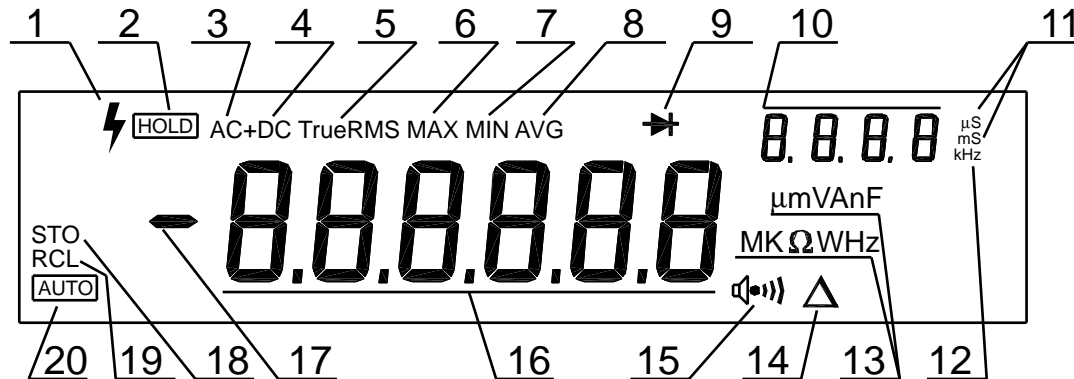
Display Symbols (see figure 3)



(figure 3)

Number	Symbol	Meaning
1		Indicator for high voltage
2	HOLD	Data hold is active
3	AC	Indicator for AC voltage or current
4	AC+DC	Indicator for AC AC Voltage or Current with DC deviation measurement
5	True RMS	Indicator for True RMS value of AC measurement
6	MAX	Display of maximum value
7	MIN	Display of minimum value
8	AVG	Display of average value
9		Test of diode
10	Smaller digits	Secondary Display
11	μS mS	The unit of frequency in cycles/second: μS: Microsecond mS: Millisecond

Number	Symbol	Meaning
12	kHz	The unit of frequency of AC measurement: KiloHertz (shown in the secondary display)
13	nF	The unit of capacitance
	μF	nF : Nanofarad
	mF	μF : Microfarad
		mF : Millifarad
	mA	A : Amperes (amps). The unit of current.
	A	mA : Milliamp
	mV	V : Volts. The unit of voltage.
		V
	Ω	Ω : Ohm. The unit of resistance.
	kΩ	kΩ : kilohm.
MΩ	MΩ : Megaohm.	

Number	Symbol	Meaning
14	△	Relative mode is on
15	•))	The continuity buzzer is on.
16	Larger digits	Primary Display
17	—	Indicates negative reading.
18	STO	Reading storage is on
19	RCL	Reading recalling is on
20	AUTO	Auto ranging mode indicator

Measurement Operation

If you have not done so, plug the line cord into the connector on the rear of the Meter.

A. DC Voltage Measurement (See figure 4)



Warning

To avoid harms to you or damages to the Meter from electric shock, please do not attempt to measure voltages higher than 1000V or 750V rms although readings may be obtained.

To measure DC voltage, connect the Meter as follows:

1. Insert the red test lead into the **V/Ω** terminal and the black test lead into the **COM** terminal.
2. Press the **DCV** button. Auto ranging is default, the Meter will select the appropriate range, and an annunciator on the display will indicate measurement units. Or you could select the manual ranging mode according to the “**Selecting a Measurement Range (▽, AUTO and △ Button)**” section.

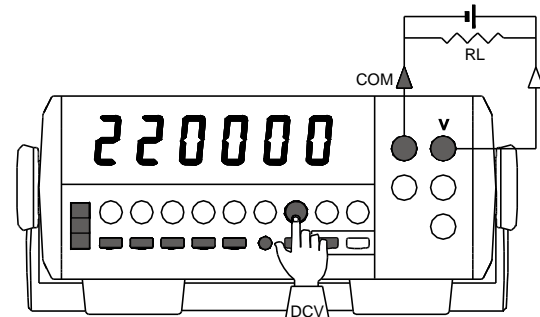

(figure 4)

3. Connect the test leads across with the object being measured as shown in figure 4. The measured value shows on the primary display and the secondary display shows the measuring range. The sampling rate is around 2 times per second.

Note

- 1 When the Meter is not zero in manual range mode, you could short circuit the test lead and press **RELΔ** to zeroing to increase the accuracy.
- 1 When DC voltage measurement has been completed, disconnect the connection between the testing leads and the circuit under test, and remove the testing leads away from the input terminals of the Meter.

B. AC Voltage Measurement (See figure 5)



Warning

To avoid harms to you or damages to the Meter from electric shock, please do not attempt to measure voltages higher than 1000V or 750V rms although readings may be obtained.

Take extra care when measuring high voltage to avoid electric shock.

To measure AC voltage, connect the Meter as follows:

1. Insert the red test lead into the **V Ω** terminal and the black test lead into the **COM** terminal.
2. Press **ACV** button, the Meter is ready for measurement after around 8 seconds. Auto ranging is default, the Meter will select the appropriate range, and an annunciator on the display will indicate measurement unit. Or you could select the manual ranging mode according to the “**Selecting a Measurement Range** (∇ , **AUTO** and \triangle Button)” section.

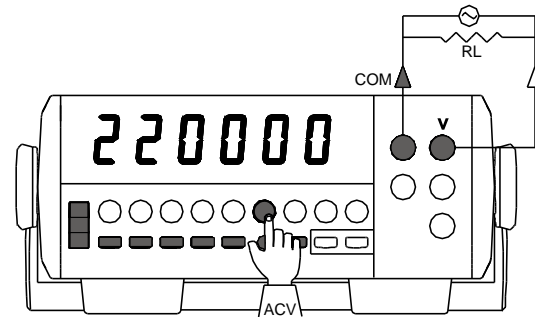

(figure 5)

3. Connect the test leads across with the object being measured as shown in figure 5. The primary display shows the True RMS AC value, the effective reading is only applicable to the range of 10%~100%. The measured signal frequency value shows on the secondary display. The sampling rate is around 1 time per second.
4. To measure AC signal with DC deviation, first press **ACV** button, then press **AC+DC** button. Otherwise, the primary display shows "--Err 1-", then back to the present measurement range.

Note

- 1 When the input terminal is short circuit, it is allowed to have maximum 500 digits of reading which does not affect the accuracy.
 - 1 When the Meter is at auto ranging mode, the True RMS transducer needs a longer time to stabilize and it requires to process AC signal frequency measurement. Therefore it takes a longer time to obtain a stable reading when changing from one reading to a relatively large reading.
- 1 When DC voltage measurement has been completed, disconnect the connection between the testing leads and the circuit under test, and remove the testing leads away from the input terminals of the Meter.

C. DC or AC Current Measurement (see figure 6)

Warning

If the fuse burns out during measurement, the Meter may be damaged or the operator himself may be hurt. Use proper terminals, function, and range for the measurement. When the testing leads are connected to the current terminals, do not parallel them across any circuit.

To measure current, connect the Meter as follows:

1. **ACI** or **DCI** measurement do not have auto ranging measurement mode.
2. Press **ACI** or **DCI** button only to select 10A measurement range. Insert the red test lead into the **10A MAX** terminal and black test lead into the **COM** terminal. OR

Press **ACI** or **DCI** button, then press **2mA** button to select 2mA measurement range. Insert the red test lead into the **200mA MAX** terminal and black test lead into the **COM** terminal. OR

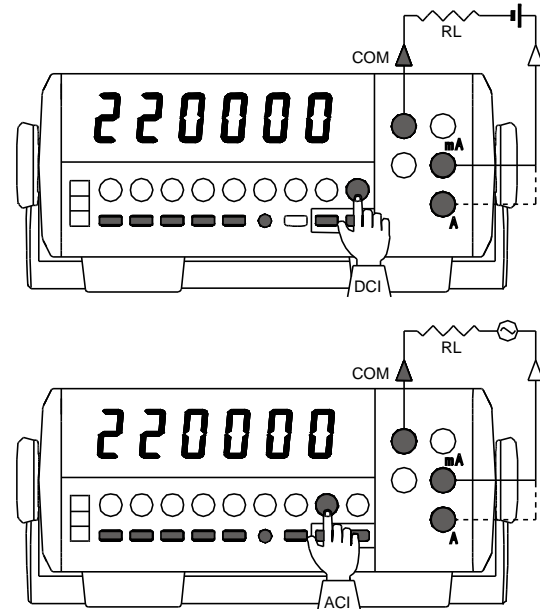

(figure 6)

Press ACI or DCI button, then press **200mA** button to select 200mA measurement range. Insert the red test lead into the **200mA MAX** terminal and black test lead into the **COM** terminal.

It is invalid to press down both 2mA and 200mA button together.\

3. Connect the test lead in serial with the object being measured. The measured value shows on the primary display.
4. The ACI effective measurement reading is only applicable to the range of 10%~100%.
5. In the DCI measurement mode, the secondary display indicates the range.
6. In the ACI measurement mode, the secondary display indicates the frequency value of the measured signal.
7. To measure AC current with DC deviation, first press ACI button, then press **AC+DC** button. Otherwise, the primary display shows "--Err 1-", then back to the present measurement range.

Note

- 1 If the value of current to be measured is unknown, use the maximum measurement position, and reduce the range step by step until a satisfactory reading is obtained.
- 1 For safety sake, each measurement time of high current (>5A) should be less than 10 seconds and the interval time between 2 measurements should be greater than 15 minutes.
- 1 When the input of AC current measurement is open circuit, it is allowed to have less than 500 digits of reading which does not affect the accuracy.
- 1 The AC current True RMS measurement takes a longer time to stabilize, and the Meter requires to measure the frequency of AC current. Therefore it is normal to take a longer time to obtain a stable reading when changing from one reading to a relatively large reading.
When current measurement has been completed, disconnect the connection between the testing leads and the circuit under test, and remove the testing leads away from the input terminals of the Meter.

D. Measuring Resistance

Warning

To avoid damages to the Meter or to the devices under test, disconnect circuit power and discharge all the high-voltage capacitors before measuring resistance. To avoid harms to you, please do not attempt to input voltages higher than 60V DC or 30V AC.

Two wire configuration measure resistance, connect the Meter as follows: (see figure 7)

1. Insert the red test lead into the **V/Ω** terminal and the black test lead into the **COM** terminal at the front panel.
2. Press the **Ω** button to enter resistance measurement mode. Auto ranging is default, the Meter will select the appropriate range, and an annunciator on the display will indicate measurement units. Or you could select the manual ranging mode according to the “**Selecting a Measurement Range (▽, AUTO and △ Button)**” section.

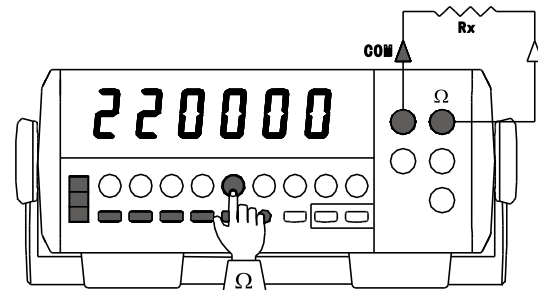

(figure 7)

Model UT805: OPERATING MANUAL

3. To obtain more accurate readings, you could short-circuit the test lead and press **REL Δ** to display "0" before carrying out measurement
4. Connect the test leads across with the object. The measured value shows on the primary display and the measuring range shows on the secondary display.

Four wire configuration measure resistance, connect the Meter as follows: (see figure 8)

1. Use 2 sets of test lead and insert them into the rear panel of the Meter.
2. Insert two red test leads into the two red terminals at the rear panel.
3. Insert two black test leads into the two black terminals at the rear panel
4. Short circuit the four test leads and press **RELΔ** to display "0".
5. Connect the test leads across with the object. The measured value shows on the primary display and the measuring range shows on the secondary display.
6. Four wire configuration measuring resistance can eliminate the influence of the test lead internal resistance, it is suitable for testing small resistance.

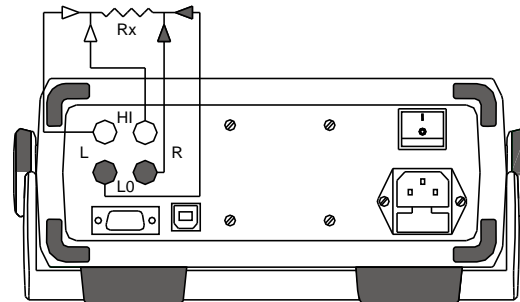

(figure 8)

Note

- 1 When measuring high resistance ($>1M\Omega$), it is normal to take several seconds to obtain a stable reading. In order to obtain stable reading, choose shorter test lead to carrying out measurement.
- 1 The LCD displays **OL** indicating open-circuit for the tested resistor or the resistor value is higher than the maximum range of the Meter.
- 1 When resistance measurement has been completed, disconnect the connection between the testing leads and the circuit under test, and remove the testing leads away from the input terminals of the Meter.

E. Testing Diodes (See figure 9)



Warning

To avoid possible damage to the Meter and to the device under test, disconnect circuit power and discharge all high-voltage capacitors before testing diodes.

To avoid harms to you, please do not attempt to input voltages higher than 60V DC or 30V AC.

Use the diode test to check diodes, transistors, and other semiconductor devices. The diode test sends a current through the semiconductor junction, and then measures the voltage drop across the junction. A good silicon junction drops between 0.5V and 0.8V.

To test a diode out of a circuit, connect the Meter as follows:

1. Insert the red test lead into $\leftarrow \text{Hz} \rightarrow \text{diode}$ terminal and the black test lead into the **COM** terminal.
2. Press $\rightarrow \text{diode}$ button to enter diode measurement mode.
3. For forward voltage drop readings on any semiconductor component, place the red test lead

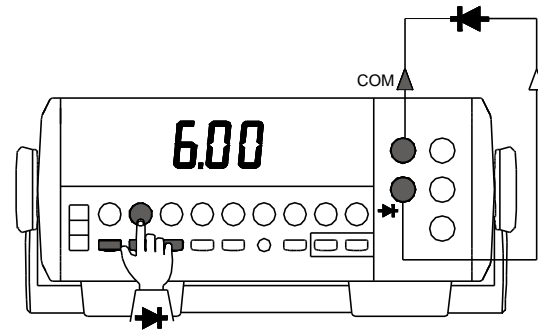

(figure 9)

on the component's anode and place the black test lead on the component's cathode.

4. The measured value shows on the primary display and the secondary display shows 6.000V range.

Note

- 1 Connect the test leads to the proper terminals as said above to avoid error display. The primary display shows OL indicating diode being tested is open or polarity is reversed. The unit of diode is Volt (V), displaying the forward voltage drop readings.
- 1 Open circuit voltage is around 2.8V.
- 1 When diode testing has been completed, disconnect the connection between the testing leads and the circuit under test, and remove the testing leads away from the input terminals of the Meter.

F. Testing for Continuity (See figure 10)

⚠ Warning

To avoid damages to the Meter or to the devices under test, disconnect circuit power and discharge all the high-voltage capacitors before testing for continuity. To avoid harms to you, please do not attempt to input voltages higher than 60V DC or 30V AC.

To test for continuity, connect the Meter as below:

1. Insert the red test lead into the \leftarrow (HZ \rightarrow \bullet) terminal and the black test lead into the **COM** terminal.
2. Press \bullet) button to enter continuity measurement mode.
3. Connect the test lead across with the object being measured.

The buzzer sounds if the resistance of a circuit under test is $< 25\Omega$, the circuit is in good condition. The primary display shows the reading of the tested resistor and the secondary displays shows 600.0 Ω range.

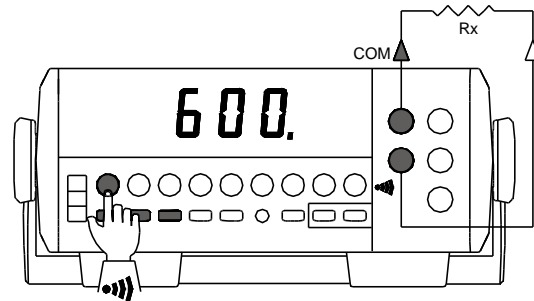

(figure 10)

Note

- 1 Open circuit voltage around 1.2V.
- 1 The primary display shows **OL** indicating the tested circuit is open.
- 1 When continuity testing has been completed, disconnect the connection between the testing leads and the circuit under test, and remove the testing leads away from the input terminals of the Meter.

G. Capacitance Measurement (See figure 11)

⚠ Warning

To avoid damage to the Meter or to the equipment under test, disconnect circuit power and discharge all high-voltage capacitors before measuring capacitance. Use the DC Voltage function to confirm that the capacitor is discharged.

To avoid harms to you, please do not attempt to input voltages higher than 60V DC or 30V AC.

To measure capacitance, connect the Meter as follows:

1. Insert the red test lead into the **(← Hz →)** terminal and the black test lead into the **COM** terminal.
2. Press **(←)** button to select capacitance measurement mode. Auto ranging is default.
3. Connect the test lead across with the object being measured. For the capacitor lead is less than 0.6mm, It is recommended to use the multi-purpose socket to proceed the measurement as the above figure 11. It is more suitable for testing small capacitor, it can reduce the influence of distributed capacitor,

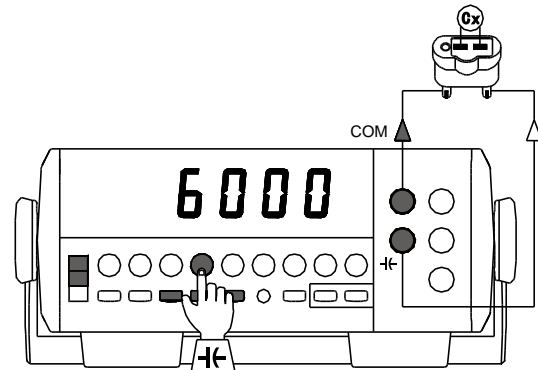

(figure 11)

4. The measured value shows on the primary display.
The secondary display shows the measuring range

Note

- 1 If the tested capacitance has polarity, connect the red test lead to the capacitor's positive and the black test lead to the capacitor's negative.
- 1 When the Meter is in open circuit and manual ranging mode, press **REL** Δ to display "0".
- 1 In the manual range mode, press Δ to up range or down range to the desired range. ∇ button cannot be used
- 1 It is normal to take a longer time when testing a capacitor value higher than $10\mu\text{F}$.
- 1 The Meter display shows **OL** indicating the tested capacitor is shorted or it exceeds the maximum range.
- 1 When capacitance measurement has been completed, disconnect the connection between the testing leads and the circuit under test and remove the testing leads away from the input terminals of the Meter.

H. Frequency Measurement (see figure 12)

Warning

To avoid harms to you, please do not attempt to input voltages higher than 60V DC or 30V AC.

To measure frequency, connect the Meter as follows:

1. Insert the red test lead into the **Hz** terminal and the black test lead into the **COM** terminal.
2. Press **Hz** button to select frequency measurement mode. Auto ranging is default.
3. Connect the test leads across with the object being measured.

The measured value shows on the primary display and the secondary display shows the cycle of the tested frequency.

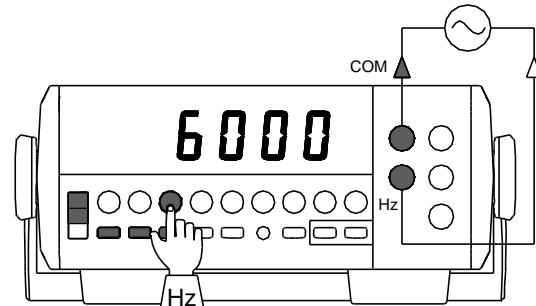

(figure 12)

Note

- 1 When making frequency measurement, it must comply with the following scope (a) requirement:
When 10Hz ~ 1Mz : $150\text{mV} \leq a \leq 30\text{V rms}$.
When > 1Mz~ 10MHz : $300\text{mV} \leq a \leq 30\text{V rms}$
When > 10Mz~ 50MHz : $600\text{mV} \leq a \leq 30\text{V rms}$
When > 50Mz : Unspecified
- 1 In the manual range mode, press Δ to up range or down range to the desired range. ∇ button cannot be used
- 1 When frequency measurement has been completed, disconnect the connection between the testing leads and the circuit under test, and remove the testing leads away from the input terminals of the Meter.

Selecting a Measurement Range (▽, AUTO and △ Button)

The Meter is default at DC Voltage 2V auto ranging measurement mode when turning on the Meter. Measurement ranges can be selected automatically by the Meter in autorange or manually by the user. In the autorange mode, the Meter selects the appropriate range for the measurement reading.

The use of the buttons of ▽, AUTO and △:

- 1 Press ▽ or △ button to enter the previous range of the auto ranging measurement mode.
- 1 To switch between measuring functions at manual ranging mode, the Meter will enter auto ranging mode automatically unless the measuring functions has only manual ranging mode. When you are in autoranging mode, the AUTO annunciator is lit.
- 1 In manual range, the Meter remains in the selected range regardless of input. Press AUTO to toggle back to autoranging.
- 1 At resistance measurement mode:
 - Auto ranging measurement mode is default.
 - Press **AUTO** to toggle in and out of the manual

ranging mode, or press ▽ or △ to toggle in the manual ranging mode.

- In the manual range mode, press ▽ or △ to up range or down range to the desired range.
- 1 At ACV and DCV measurement mode:\
 - Auto ranging measurement mode is default.
 - Press **AUTO** to toggle in and out of the manual ranging mode, or press ▽ or △ to toggle in the manual ranging mode.
 - In the manual range mode, press ▽ or △ to up range or down range to the desired range.
 - At 200mV range, the Meter does not have auto ranging measurement mode.
 - 1 At capacitance and frequency measurement mode:
 - Auto ranging measurement mode is default.
 - Press **AUTO** to toggle in and out of the manual ranging mode, or press △ to toggle in the manual ranging mode.
 - In the manual range mode, press △ to up range or down range to the desired range.
 - ▽ cannot be used.
 - 1 At diode, continuity, ACI and DCI measurement mode, both ▽ and △ cannot be used.

The Use of Relative Value Mode

Relative Mode applies to all functions except continuity, diode and frequency measurements.

When the relative mode is selected, the reading on the primary display is always the difference between the relative base and the input measurement. For example, if the relative base is 15.0000V, and the present reading is 14.1000V, the display will show -00.9000.

Press **REL**△ to toggle in and out of the relative mode. When the relative mode is selected: the last valid reading is stored as the relative base, the primary display zeros out and display "0", △ is shown on the primary display. (The secondary display is unaffected.)

Selecting the relative mode turns off autoranging and locks in the present range. Make sure you are in the correct range before selecting the relative mode. If you press ▽ or △ after the relative mode has been selected, you will automatically exit △.

AUTO cannot be pressed, otherwise "--Err 1--" will be displayed and then back to the current measurement range

To enter or exit REL mode:

- 1 Press **REL**△ to enter REL mode, the Meter displays △, auto ranging turns off, and the present measurement range is locked and stored the present measurement value as the stored value, the Meter displays "0". The present measurement value obtained later on is the difference of the stored value.
- 1 Press **REL**△ again to exit REL mode.
- 1 Press **REL**△ again to step the display through the above sequence.

MAX MIN Mode

MAX MIN mode applies only to DCV, ACV, ACV and ACI with DC deviation, and resistance. Press **MAX MIN** when the Meter is at other measurements mode, the Meter displays "--Err 1-" and then back to the current measurement mode.

The MAX MIN mode causes the Meter to store minimum and maximum inputs measured since the MAX MIN was selected.

Press **MAX MIN** to select the MAX MIN mode. When the **MAX MIN** is first selected, the maximum and minimum values are set to the displayed reading and the MAX annunciator lights. Press **MAX MIN** again to display the minimum reading (and the MIN annunciator lights.) Each subsequent press of the **MAX MIN** button toggles between the maximum and minimum measurements taken. To exit MAX MIN mode, press **HOLD** button..

Selecting the MAX MIN mode turns off autoranging and locks in the present range. Make sure you are in the correct range before selecting the MAX MIN mode. If you press ∇ or Δ after **MAX MIN** has been selected, you will automatically exit the MAX MIN mode.

Measurement speed is 100 times / second. The display flashes "**OL**" when the testing exceeds the measurement speed.

MAX MIN mode and REL mode cannot be used together. The Meter displays "--Err 1-" and then back to the current measurement mode if **REL** Δ is pressed under MAX MIN mode.

The Use of STO and RCL Button



STO Button

- 1 Press STO to step through 7 different storage speed including r=0, r=1, r=2, r=3, r=4, r=5 and r=6, they will be shown on the secondary display.
- 1 r=0 means store each reading per each sampling.
r=1 means store each reading per 10 times sampling
r=2 means store each reading per 100 times sampling
r=3 means store each reading per 500 times sampling
r=4 means store each reading per 1000 times sampling
r=5 means store each reading per 5000 times sampling
r=6 means manual storage. You need to press **STO** for each reading storage.
- 1 The maximum pieces of stored reading is 100. "RCL" will be flicking on the VFD when the stored value is over 100pcs. You need then need to recall the reading,
- 1 Press **HOLD** to exit STO mode.

- 1 Follow the following procedure to recall the stored reading:
 1. Press **HOLD** to exit STO mode.
 2. Press **RCL** to step through MAX reading, MIN reading, AVG reading, the first stored reading (n=00), the second stored reading (n=02) until the 100st stored reading (n=99) in sequence.
 3. Press **HOLD** to exit RCL mode.
- 1 When recalling the stored reading, the Meter must be at the stored reading measurement ranges, otherwise it will display "--Err 3--", then back to new measurement ranges.-
- 1 When the Meter is at STO mode, pressing **RCL** two times to display through MAX reading, MIN reading, AVG reading and the present measurement reading in sequence. Reading storage is unaffected.



Operation of Hold Mode

The Hold mode allows you to take a measurement and hold that measurement on the display. This feature can be particularly advantageous in difficult or hazardous circumstances when you might want to keep your eyes fixed on the probes, and then read the display when it is safe or convenient to do so. When a new, stable reading is detected, the display is automatically updated.

Press **HOLD** to select Hold mode. When hold mode is selected,  is shown in the primary display. The current reading on the display is hold. To exit hold mode, press HOLD again,  will be disappeared.

You can also press **HOLD** to exit STO, RCL and MAX MIN mode when the Meter is at STO, RCL and MAX MIN measurement mode.

General Specifications

- 1 Maximum Voltage between any Terminals and Grounding:
Refer to different range input protection voltage.
- 1  Fused Protection for 200mA Input Terminal:
315mA, 250V, fast type, ϕ 5x20mm.
- 1  Fused Protection for 10A Input Terminal:
10A, 250V, fast type, ϕ 5x20mm.
- 1  Fused Protection for AC220V Terminal:
315mA, 250V, fast type, ϕ 5x20mm.
- 1 Maximum Display:
Main LCD Display : 220000,
Small LCD Display: 9999, VFD
- 1 Measuring Theory:
 Σ - Δ type, A/D converter
- 1 Measurement Speed:
Updates around 2 times/second. At max/min mode,
updates 100 times/second
- 1 Range:
Manual or auto ranging.

1 Icon Display:

Equipped with functions and electrical unit symbol icon display.

1 Polarity Display: Auto

1 Overloading Display: OL

1 Temperature:

Operating: 0°C to +40°C (32°F to +104°F).

Storage : -10°C to +50°C (14°F to +122°F).

1 Relative Humidity:

≤75% @ 0°C - 30°C below; ≤50% @ 30°C - 40°C.

1 Altitude:

Operating: 2000 m.

Storage : 10000 m.

1 Power:

AC220V~50Hz, 15W or AC110V~50Hz, 15W

1 Dimensions (HxWxL):

240 x 105 x 370 mm.

1 Weight:

Approximate 2.9kg (accessories: 0.4kg).

1 Safety/Compliances:

IEC61010 CAT.I 1000V, CAT.II 600V overvoltage and double insulation standard.

1 Certifications:

CE UL pending.

Accuracy Specifications

Accuracy: $\pm(a\% \text{ reading} + b \text{ digits})$, guarantee for 1 year. Operating temperature: $23^{\circ}\text{C} \pm 5^{\circ}\text{C}$.

Relative humidity: not more than 75% RH. Temperature coefficient: $0.1 \times (\text{specified accuracy})/1^{\circ}\text{C}$.

Note

- 1 UT805 multimeter is a precise digital multimeter when you turn on the UT805 allow a warm-up period of at least 30 minutes for the internal components to stabilize this ensures that the multimeter accord with the specification

A. DC Voltage

Range	Measurement Scope	Resolution	Accuracy
200mV	1 μ V~220.000mV	1 μ V	In REL mode: $\pm(0.006\%+2)$
2V	10 μ V~2.20000V	10 μ V	
20V	100 μ V~22.0000V	100 μ V	$\pm(0.007\%+2)$
200V	1mV~220.000V	1mV	
1000V	10mV~1000.00V	10mV	

Remarks:

- 1 **Overload Protection:** 1000V DC or 750V AC

1 Input Impedance:

At 200mV and 2V ranges: more than 500M Ω

At 20V, 200V and 1000V ranges: Around 10M Ω

B. AC Voltage (True RMS)

Range	Resolution	Accuracy			
		40Hz~10kHz	>10~30kHz	>30~50kHz	>50~100kHz
200mV	1μV	±(0.1%+100)	±(0.2%+200)	±(0.3%+200)	±(0.5%+300)
2V	10μV				
20V	100μV	±(0.2%+100)	±(0.3%+200)	±(1%+500)	±(2%+500)
200V	1mV			N/A	N/A
750V	10mV	40Hz-1kHz: ±(0.3%+100)	>1kHz-5kHz: ±(0.4%+100)	N/A	N/A

Remarks:

1 **Overload Protection:** 1000V DC or 750V AC

1 **Input Impedance:** 10MΩ

1 **AC+DC Tolerance Limit:** Same as AC + 1%

1 **Displays:**

- The effective reading is only applicable to the range of 10%~100%.
- The full range of each measurement range displays 220000 except at AC750V measurement range.

C. DC Current

Range	Measurement Scope	Resolution	Accuracy
2mA	0.01μA~2.20000mA	0.01μA	±(0.03%+10)
20mA	1μA~220.000mA	1μA	
10A	0.1mA~10.0000A	0.1mA	±(0.8%+60)

Remarks:

1 **Overload Protection:**

At mA Range: Fuse 315mA, 250V, fast type, φ 5x20mm.

At A Range : Fuse 10A, 250V, fast type, φ 5x20mm.

1 **At ≤5A range :**Continuous measurement is allowed.

1 **At >5A range:**For continuous measurement ≤10 seconds and interval not less than 15 minutes.

D. AC Current (Frequency range: 40Hz~5kHz)

Range	Measurement Scope	Resolution	Accuracy
2mA	0.01μA~2.20000mA	0.01μA	±(0.3%+100)
20mA	1μA~220.000mA	1μA	
10A	0.1mA~10.0000A	0.1mA	±(2%+200)

Remarks:

1 **Overload Protection:**

At mA Range: Fuse 315mA, 250V, fast type, φ 5x20mm.

At A Range : Fuse 10A, 250V, fast type, φ 5x20mm.

1 **At ≤5A range:** Continuous measurement is allowed.

1 **At >5A range:** For continuous measurement ≤10 seconds and interval not less than 15 minutes.

1 **Displays :** The effective reading is only applicable to the range of 10%~100%.

1 **AC+DC Tolerance Limit:** Same as AC + 1%.

E. Resistance

Range	Measurement Scope	Resolution	Accuracy
2kΩ	0.01Ω~2.20000kΩ	0.01Ω	In REL mode:±(0.01%+8)
20kΩ	0.1Ω~22.0000kΩ	0.1Ω	In REL mode: ±(0.01%+5)
200kΩ	1Ω~220.000kΩ	1Ω	
2MΩ	10Ω~2.20000MΩ	10Ω	±(0.02%+10)
20MΩ	100Ω~22.0000MΩ	100Ω	±(0.1%+20)

Remarks:

- 1 **Overload Protection** : 1000V DC or 750V AC
- 1 **Open Circuit Voltage**:Around 2V

F. Diode Test

Range	Measurement Scope	Resolution	Overload Protection	Remarks
	0.00~6.00V	10mV	250Vp	<ul style="list-style-type: none"> Open circuit voltage approximate 2.8V. A good silicon junction drops between 0.5V and 0.8V

G. Continuity Test

Range	Measurement Scope	Resolution	Overload Protection	Remarks
	0~600Ω	1Ω	250Vp	<ul style="list-style-type: none"> Open circuit voltage approximate -1.2V. When circuit disconnected with resistance value $\geq 50\Omega$, buzzer does not beep. When circuit is in good connection with resistance value $\leq 10\Omega$, buzzer beeps continuously.

H. Capacitance

Range	Measurement Scope	Resolution	Accuracy
6nF	1pF~5.999nF	1pF	In REL mode: $\pm(2.5\%+5)$
60nF	10pF~59.99nF	10pF	In REL mode: $\pm(2.0\%+5)$
600nF	100pF~599.9nF	100pF	$\pm(2.0\%+5)$
6 μ F	1nF~5.999 μ F	1nF	
60 μ F	10nF~59.99 μ F	10nF	
600 μ F	100nF~599.9 μ F	100nF	$\pm(5.0\%+5)$
6mF	1 μ F~5.999mF	1 μ F	Un-Specified

Remarks:

I **Overload Protection:** 250Vp

I. Frequency

Range	Measurement Scope	Resolution	Accuracy
6kHz	1Hz~5.999kHz	1Hz	±(0.1%+3)
60kHz	10Hz~59.99kHz	10Hz	
600kHz	100Hz~599.9kHz	100Hz	
6MHz	1kHz~5.999MHz	1kHz	
60MHz	10kHz~59.99MHz	10kHz	

Remarks:

- 1 **Overload Protection:** 250Vp
- 1 **Input scope (a):** (DC electric level is zero)
 - When 10Hz ~ 1MHz: $150\text{mV} \leq a \leq 30\text{V rms}$
 - When > 1MHz ~ 10MHz: $300\text{mV} \leq a \leq 30\text{V rms}$
 - When > 10MHz ~ 50MHz: $600\text{mV} \leq a \leq 30\text{V rms}$
 - When > 50MHz: Unspecified

CALIBRATION PROCEDURE

- 1 The calibration must be done in manual ranging mode.
- 1 Power-up the Meter and allow it to stabilize for one hour.
- 1 The accuracy of the original source must be 1/3 better than the calibrated range

A. DC Voltage (Calibrate both positive and negative polarity)

- 200mV: Short circuit the test lead, press **REL** Δ to display "0", input $\pm 190\text{mV}$, then press **CAL** button.
The Meter displays: (--CAL--) \rightarrow (-HI-END) \rightarrow (190.000mV), calibration finished.
- 2V : Short circuit the test lead, press **REL** Δ to display "0", input $\pm 1.9\text{V}$, then press **CAL** button.
The Meter displays: (--CAL--) \rightarrow (-HI-END) \rightarrow (1.90000V), calibration finished.
- 20V : Short circuit the test lead, press **REL** Δ to display "0", input $\pm 19\text{V}$, then press **CAL** button.
The Meter displays: (--CAL--) \rightarrow (-HI-END) \rightarrow (19.0000V), calibration finished.
- 200V : Short circuit the test lead, press **REL** Δ to display "0", input $\pm 190\text{V}$, then press **CAL** button.
The Meter displays: (--CAL--) \rightarrow (-HI-END) \rightarrow (190.000V), calibration finished.
- 1000V : Short circuit the test lead, press **REL** Δ to display "0", input $\pm 1000\text{V}$, then press **CAL** button.
The Meter displays: (--CAL--) \rightarrow (-HI-END) \rightarrow (1000.00V), calibration finished.

B. AC Voltage(750V range: frequency 1kHz, all other ranges: frequency 20kHz)

- 200mV: Input 19mV, press **CAL** button to display (-- CAL--) → (-LO-END) → (*****). Input 190mV, press **CAL** button to display (--CAL--) → (-HI-END) → (190.000mV), calibration finished
- 2V : Input 190mV, press **CAL** button to display (--CAL--) → (-LO-END) → (*****). Input 1.9V, press **CAL** button to display (-- CAL--) → (-HI-END) → (1.90000V), calibration finished.
- 20V : Input 1.9V, press **CAL** button to display (-- CAL--) → (-LO-END) → (*****). Input 19V, press **CAL** button to display (-- CAL--) → (-HI-END) → (19.0000V), calibration finished.
- 200V : Input 19V, press **CAL** button to display (--CAL--) → (-LO-END) → (*****). Input 190V, press **CAL** button to display (-- CAL--) → (-HI-END) → (190.000V), calibration finished.
- 750V : Input 190V, press **CAL** button to display (-- CAL--) → (-LO-END) → (*****). Input 750V, press **CAL** button to display (-- CAL--) → (-HI-END) → (750.00V), calibration finished.
- AC+DC: Carry out the calibration according to each range of DC voltage.

C. DC Current (Calibrate both positive and negative polarity)

- 2mA : Press **REL** to display "0", input $\pm 1.9\text{mA}$, press **CAL** button to display (--CAL--) → (-HI-END) → ($\pm 1.90000\text{mA}$), calibration finished.
- 200mA : Press **REL** to display "0", input $\pm 190\text{mA}$, press **CAL** button to display (--CAL--) → (-HI-END) → ($\pm 190.000\text{mA}$), calibration finished
- 10A : Press **REL** to display "0", input $\pm 10\text{A}$, press **CAL** button to display (--CAL--) → (-HI-END) → ($\pm 10.0000\text{A}$), calibration finished

D. AC Current (Frequency: 1kHz)

- 2mA : Input 0.19mA , Press **CAL** button to display (--CAL--) → (-LO-END) → (*****). Input 1.9mA , Press **CAL** button to display (--CAL--) → (-HI-END) → (1.90000mA), calibration finish.
- 200mA : Input 19mA , Press **CAL** button to display (--CAL--) → (-LO-END) → (*****). Input 190mA , Press **CAL** button to display (--CAL--) → (-HI-END) → (190.000mA), calibration finish
- 10A : Input 1.9A , Press **CAL** button to display (--CAL--) → (-LO-END) → (*****). Input 10A , Press **CAL** button to display (--CAL--) → (-HI-END) → (10.0000A), calibration finish
- AC+DC: AC+DC: Carry out the calibration according to each range of DC current.

E. Resistance

- $2k\Omega$: Press **REL** to display "0", input $\pm 1.9k\Omega$, press **CAL** button to display (--CAL--) → (-HI-END) → ($\pm 1.90000k\Omega$), calibration finished.
- $20k\Omega$: Press **REL** to display "0", input $\pm 19k\Omega$, press **CAL** button to display (--CAL--) → (-HI-END) → ($\pm 19.0000k\Omega$), calibration finished.
- $200k\Omega$: Press **REL** to display "0", input $\pm 190k\Omega$, press **CAL** button to display (--CAL--) → (-HI-END) → ($\pm 190.000k\Omega$), calibration finished.
- $2M\Omega$: Press **REL** to display "0", input $\pm 1.9M\Omega$, press **CAL** button to display (--CAL--) → (-HI-END) → ($\pm 1.90000M\Omega$), calibration finished.
- $20M\Omega$: Press **REL** to display "0", input $\pm 19M\Omega$, press **CAL** button to display (--CAL--) → (-HI-END) → ($\pm 19.0000M\Omega$), calibration finished

F. AC Voltage with DC deviation (AC+DC)

1. Press **ACV** button
2. Press **AC+DC** button
3. Follow the above "B. AC Voltage" procedure

G. AC Current with DC deviation (AC+DC)

1. Press **ACI** button
2. Press **AC+DC** button
3. Follow the above "D. AC Current" procedure.

SUMMARY OF ERROR CODES

If the Meter is failed to operate properly, an error code is displayed in the primary display. Error codes are listed in below table:

Error Code	Description
Err1	Wrong button is pressed
Err2	At AVG mode, the number of average times > 999998, out of range. At REL mode, the stored value > 220000, out of range.
Err3	The present measurement range and the range of the stored reading is not the same when recalling the reading
Err4	The tested reading is out of the calibration scope

Maintenance

This section provides basic maintenance information including general service and fuse replacement instruction.



Warning

Do not attempt to repair or service your Meter unless you are qualified to do so and have the relevant calibration, performance test, and service information. To avoid electrical shock or damage to the Meter, do not get water inside the case.

A. General Service

- 1 Calibrate the Meter around once a year to ensure the accuracy of each functions.
- 1 Periodically wipe the case with a damp cloth and mild detergent. Do not use abrasives or solvents.
- 1 To clean the terminals with cotton bar with detergent, as dirt or moisture in the terminals can affect readings.
- 1 Turn off the power of the Meter when it is not in use.
- 1 Do not use or store the Meter in a place of humidity, high temperature, explosive, inflammable and strong magnetic field.

B. Replacing the Fuses (see figure 13)

Warning

To avoid electrical shock or arc blast, or personal injury or damage to the Meter, use specified fuses ONLY in accordance with the following procedure.

To replace the Meter's fuse:

1. Turn the Meter off, disconnect the power cord and remove all connections from the terminals.
2. Fuse 1: The line power fuse is in series with the power supplier. This fuse is located at the top of the power-line cord connector on the rear panel.

To replace this fuse, unplug the line cord and remove the line power fuse housing to install the replacement fuse.

Fuse 2 and 3: These two fuses are located inside the fuse compartment. To replace these fuses, first unplug the line cord. Then use a coin to open the accessories compartment at the top of the front cover, then you will see a fuse compartment. Open the fuse compartment to replace fuse 2 and 3. Remove the fuse by gently prying one end loose, then take out

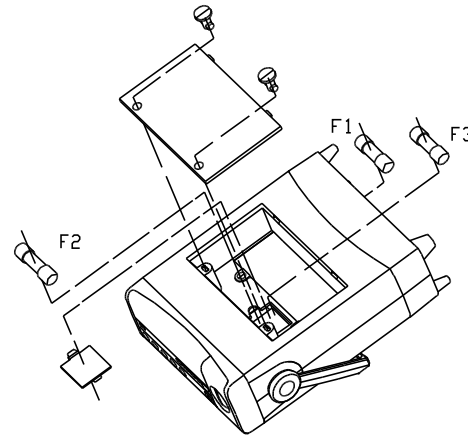

(figure 13)

the fuse from its bracket. Then install the replacement fuse.

3. Install ONLY replacement fuses with the identical type and specification as follows and make sure the fuse is fixed firmly in the bracket.

Fuse 1: 315mA, 250V, fast type, ϕ 5x20mm (AC220V)

Fuse 2: 315mA, 250V, fast type, ϕ 5x20 mm (mA)

Fuse 3: 10A, 250V, fast type, ϕ 5x20 mm (A)

Replacement of the fuses is seldom required. Burning of a fuse always results from improper operation.

RS232C and USB Serial Port

System Requirements for Installing the UT805 Interface Program

To use **UT805 Interface Program**, you need the following hardware and software:

- 1 An IBM PC or equivalent computer with 80486 or higher processor and 600 x 800 pixel or better monitor.
- 1 Microsoft Windows 95 or above.
- 1 At least 8MB of RAM.
- 1 At least 8MB free space in hard drive.
- 1 Can access to a local or a network CD-ROM.
- 1 A free serial port.
- 1 A mouse or other pointing device supported by Windows.

RS232C Serial Port

A. Connecting between the Meter and computer
(see figure 14)

B. RS232C Port Cable

The Meter	Computer	
D-sub 9 Pin Male	D-sub 9 Pin Female	D-sub 25 Pin Female
2 (RXD)	3 (TXD)	2 (TXD)
3 (TXD)	2 (RXD)	3 (RXD)
5 (SG)	5 (SG)	7 (SG)

C. Setting of RS232C Serial Ports

Default of RS232C serial port for communication is set as:

Baud Rate 19200
 Start bit always 0
 Stop bit always 1
 Data bits 8
 Parity Odd

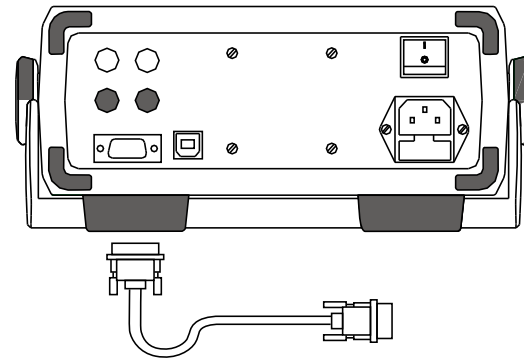

(figure 14)

Model UT805: OPERATING MANUAL

Serial port output 25 bits. Each bit is an alphabet, below table explains the meaning of each alphabet:

Number	1	2	3	4	5	6	7
1	\$	S (STO)	X (MAX)	C (Continuity)	E (REL)	!	-
2	Start Character	R (RCL)	N (MIN)	D (Diode)	U (AUTO)	High Voltage	+
3		D (STO+RCL)	G (AVG)	A (AC)			C
4		H (HOLD)		± (AC+DC)			E
5							

Number	8-14	15	16	17-21	22	23	24	25
1	6 Digit + dp	k	V	4 Digit + dp	k (kHz)	#	CR	LF
2		M	A		m (mS)	End Character		
3		μ	F		μ (μS)			
4		m	Ω (Ω)					
5		n	H (Hz)					

The Meter adopts a single large alphabet command, each command is sent out twice as below table:

Number	1	2	3	4	5
Command	A	B	C	D	E
Meaning	DCI	•))	→	ACI	AC+DC
Number	10	11	12	13	14
Command	J	K	L	M	N
Meaning	ACV	REL	HOLD	Ω	↓

When the Meter receives the computer sent command, same large alphabet command twice, it will return the same alphabet. The Meter will not response if a wrong alphabet command is received.

USB Serial Port

A. Connecting between the Meter and computer (see figure 15)

B. Setting of USB Serial Ports

Install the USB serial port driver according to the Installation Guide & Computer Interface Software before connecting the Meter and computer.

Check for the USB Serial port shown at the Control Panel => System => Device Manager. Make sure connect the Meter and the computer with the same port.

Please refer to the included “**Installation Guide & Computer Interface Software**” for installing and operating instructions of the **UT805 Interface Program**.

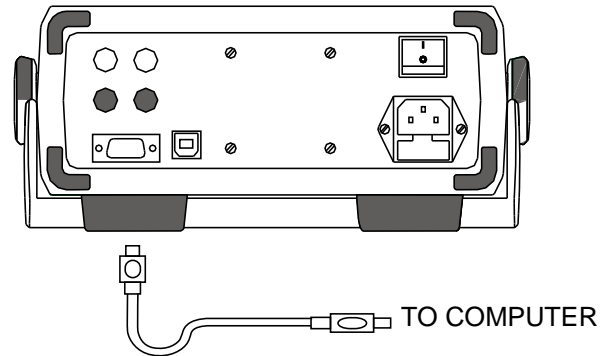

(figure 15)

END

This operating manual is subject to change without notice.
© Copyright 2005 Uni-Trend International Limited.
All rights reserved.

Manufacturer: UNI-TREND TECHNOLOGY(DONG GUAN)LIMITED
Address: Dong Fang Da Dao, Bei Shan Dong Fang Industrial
Development District, Hu Men Town, Dong Guan City,
Guang Dong Province, China

Headquarters: Uni-Trend International Limited
Address: Rm901, 9/F, Nanyang Plaza 57 Hung To Road
Kwun Tong Kowloon, Hong Kong

Tel: (852) 2950 9168

Fax: (852) 2950 9303

Email: info@uni-trend.com

<http://www.uni-trend.com>