

Table of Contents

- A. Your Meter's Feature
- B. Specifications
- C. Making Measurements
- D. Maintenance
- E. Accessories
- F. Using Holster
- G. Using Strap











Introduction

UT57 is one type of UNI-T brand new UT50 series Multimeters with 4 1/2 digits, which has special and steady function and is a highly reliable hand-held measuring instrument. The design of the Meter is the use of CMOS technology with large scale of integrated circuit using double integrated A/D transducer as its core and has full ranges overload protection. The Meter can measure DC current, AC current, DC Voltage, AC Voltage, Resistance, Capacitance, Diode, Frequency and Continuity Beeper. AC Voltage and Current measurement is TRMS and has the function of AC+DC/AC which is an ideal tool for users.

Safety Rules

- 1 Use the Meter only as specified in this manual, otherwise the protection provided by the Meter may be impaired.
- 1 The meter is designed to withstand the stated Max. voltages. If it is not possible to exclude without doubts that impulses, transients, disturbance or for other reasons, these voltages are exceeded a suitable prescale (10:1) must be used.
- 1 Do not operate the Meter before the cabinet has been closed and screwed safely as terminal can carry voltage.
- 1 Make sure the Meter is set to the suitable range before each measurement.
- 1 Before using the Meter, please inspect the case and test leads for damaged insulation or exposed metal.
- 1 Connect the red and black test lead to the correct measuring input jack properly.
- 1 Do not input values over the maximum range of each measurement to avoid damages of the Meter.
- 1 Do not turn the rotary function switch during Voltage or Current measurement, otherwise the Meter could be destroyed

- 1 **Make sure to use new fuses with proper rating to instead of bad fuses.**
- 1 **To avoid electric shock or damages, do not apply more than 1000V between the “COM” terminals and “⏏”earth ground.**
- 1 **Use caution when working with Voltages above 60V (DC) or 30Vrms (AC). These Voltages pose shock hazard.**
- 1 **Replace the battery as soon as the battery indicator “” appears. With a low battery, the Meter might produce false readings that can lead to electric shock and personal injury.**
- 1 **Turn off the Meter once finished measuring.**
- 1 **Do not operate the Meter under adverse environmental condition including high temperature and especially humid area as the Meter's function may be effected after moisturizing.**
- 1 **To avoid damages and dangers, do not change the circuit.**
- 1 **Periodically wipe the cabinet with a damp cloth and mild detergent. Do not use abrasives or solvents.**
- 1 **International Electrical Symbols:**

	Low Battery		Earth Ground
	Warning		Double Insulated
	AC		Diode
	DC		Buzzer
	Fuse		
	Dangerous Voltages		

A. Your Meter's Feature

- 1 21 ranges.
- 1 Liquid Crystal Display, digit's height is 21mm .
- 1 Overload display "1".
- 1 Maximum display "19999".
- 1 Full range symbol display.
- 1 Full range overload protection.
- 1 Auto-Power Off.
- 1 Operating Temperature:
0°C to 40°C (32 °F to 104 °F) .
- 1 Storing Temperature:
-10°C to 50°C (14 °F to 122 °F) .
- 1 Altitude:Operation:2000m.
Storage:10000m.
- 1 Relative humidity:Max.relative humidity 80%
for temperature up to 31°C decreasing.
linearly to 50% relative humidity at 40°C.
- 1 Low Battery display "⚡"
- 1 Battery type:9V Zinc,NEDA1604 or 6F22
or 006P.
- 1 Fuse:F.0.3A/250V ϕ 5x20mm.
F.10A/250V ϕ 6x25mm.
- 1 Measuring Dangerous Voltage display "⚠"
- 1 Strap for easy carry.
- 1 Dimension: 190 x 88 x 34mm.
- 1 Weight: about 270gram (excluding test
leads).

B. Specifications

Accuracy is specified for one year after calibration, at operating temperatures $23^{\circ}\text{C} \pm 5^{\circ}\text{C}$, with relative humidity at $<75\%$. Accuracy specifications take the form of: $\pm(a\% \text{ readings} + n \text{ digits})$

B-1 Direct Current Voltage (DC Voltage)

Range	Resolution	Accuracy
200mV	10 μV	$\pm (0.05\% + 3)$
2V	100 μV	
20V	1mV	
200V	10mV	$\pm (0.1\% + 5)$
1000V	100mV	

⚠ Input impedance: All ranges are 10M Ω .

Overload protection: 200mV is 230VDC or AC RMS. All other ranges are 750Vrms or 1000Vp-p.

B-2 Alternate Current Voltage (AC Voltage)

Range	Resolution	Accuracy
		40~400Hz
200mV	10 μV	$\pm (0.8\% + 20)$
2V	100 μV	
20V	1mV	
200V	10mV	$\pm (1.0\% + 50)$
750V	100mV	

⚠ Input impedance: All ranges are 10M Ω .

Frequency: 40Hz-400Hz.

Overload protection: 200mV is 230VDC or AC RMS. All other ranges are 750Vrms **or** 1000Vp-p.

Display: TRMS (True Root Mean Square of Sine Wave).

B-3 Direct Current Current (DC Current)

Range	Resolution	Accuracy
20mA	1 μ A	\pm (0.5% +2)
200mA	10 μ A	\pm (0.8% +5)
10A	1mA	\pm (2% +10)

⚠ Overload protection: Below 200mA with
 F. 0.3A/250V Fused. 10A with
 F. 10A/250V Fused.

Max current input: For 10A range ,measuring
 time \leq 10 seconds,interval time \geq 15 Minutes.

Measuring voltage drop: Full ranges are 200mV.

B-4 Alternate Current Current (AC Current)

Range	Resolution	Accuracy
20mA	1 μ A	\pm (1.0% +20)
200mA	10 μ A	
10A	1mA	\pm (2.0% +20)

⚠ Overload protection: Below 200mA with
 F. 0.3A/250V Fused. 10A with
 F. 10A/250V Fused.

Max current input: For 10A range ,measuring
 time \leq 10 seconds,interval time \geq 15 Minutes.

Measuring voltage drop: Full ranges are 200mV.

Display: TRMS (Crest factor reach five)

B-5 Resistance

Range	Resolution	Accuracy
200Ω	0.01Ω	±(0.1% +5)
2KΩ	0.1Ω	±(0.1% +2)
20KΩ	1Ω	
200KΩ	10Ω	
2MΩ	100Ω	
20MΩ	1KΩ	±(0.3% +10)

⚠ Overload protection: All ranges are 230VDC or AC RMS.

Voltaeg at Open Circuit: About 3V

Caution: At 200Ω range, short the test lead first to obtain the resistance value of the test leads. Deduct the resistance value from the measured reading to obtain the correct value of the object being measured .

B-6 Capacitance

Range	Resolution	Accuracy
20nF	1pF	± (2.0% +10)
200nF	10pF	
2μF	0.1nF	
20μF	1nf	± (2.5% +30)



Testing Signals: About 400Hz, 40mVrms.

2-7 Frequency

Range	Resolution	Accuracy
20kHz	1Hz	± (1.0% +20)
200kHz	10Hz	

⚠ Input sensitivity: ≈ 200 mV rms,
 Max Input Scope: ≈ 30 V rms.
 Overload protection: 230V rms





2-8 Diode and Continuity Beeper



Range	Remark	Measuring Condition
	Display Diode Forward Voltage Value, unit is "V"	Forward DC Current abt 1mA, Backward DC Voltage abt 2.8V
	Beeper sounds when Resistance < 30Ω. Display the nearest value, unit is "kΩ"	Voltage at open Circuit abt 3.0V

⚠ Overload protection: 230V DC or AC RMS.

C. Making Measurements

Caution

- (1) If there is no display or “” is shown on the LCD when the Meter is switched on, replace the battery ASAP.
- (2) Never exceed the maximum input voltage or current limits shown besides the input jacks “”, otherwise the Meter’s internal circuit will be damaged and this is dangerous to life.
- (3) Become familiar with all buttons, and Turn the rotary switch to proper range before operating.
- (4) Put the /~ On/Off button at “” position as do not measure AC current or voltage, otherwise, The LCD will appear “AC” symbol.

1. LCD Display
2. /~ On/Off Button
3. /~ On/Off Button
4. Rotary Switch
5. COM Input Jack
6. Capacitance Jack
7. Power On/Off Button
8. Data-Hold Button
9. 200mA~10A Input Jack
10. Below 200mA Input Jack
11.  V Ω Hz Input Jack

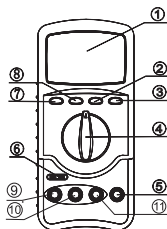

C-1 Measuring DC Voltage

- 1) $\overline{\text{DC}}$ / \sim Button should not be pressed down and LCD should not display "AC" Symbol.
- 2) Connect the black test lead to "COM" jack and red test lead to "V" jack.
- 3) Set the rotary switch to " $\overline{\text{DC}}$ "
- 4) Connect the test leads across with the object to be measured. LCD appears the measuring value and also the polarity of the red test leads.

Caution

- 1) If magnitude of the voltage is unknown, always start with the highest range and reduce until satisfactory reading is obtained.
- 2) If "1" is shown on the LCD, it means the Meter is overloaded, then set the measuring range to higher.
- 3) " Δ " means never exceed the maximum input limits, 1000V, otherwise internal circuit of the Meter will be damaged even though it is still possible to display higher voltage value.
- 4) Take extra care of voltage leakage when measuring high voltage.

C-2 Measuring AC Voltage



- 1) Press down $\overline{\text{DC}}$ / \sim button to display "AC" on LCD. If $\sim + \overline{\text{DC}}$ / \sim button is not pressed, it means the measuring value is the sum of Direct and Alternate Current ($\sim + \overline{\text{DC}}$). While if $\sim + \overline{\text{DC}}$ / \sim button is pressed, it means the measuring value is a pure Alternate Current TRMS.

- 2) Connect the black test lead to "COM" jack and red test lead to "V" jack.
- 3) Set the rotary switch to "V~"
- 4) Connect the test leads across with the object to be measured.

Caution

- 1) Refer to "DC Voltage Caution" 1, 2, 4
- 2) "△" means never exceed the maximum input limits, 750V, otherwise internal circuit of the Meter will be damaged even though it is still possible to display higher voltage value.
- 3) The input value should be 10% more than the selected ranges to fulfill accuracy requirement.

C-3 Measuring DC Current

- 1) Press  /  button down not to display "AC" on the LCD
- 2) Connect the black test lead to "COM" jack. When measuring 200mA or below, connect the red test lead to "mA" jack. When measuring 10A or below, connect the red test lead to "10A" jack.
- 3) Set the rotary switch to "A 
- 4) Connect the test leads in series with the object to be measured, the LCD display the measuring value and polarity of red test lead.

Caution

- 1) If magnitude of the current is unknown, always start with the highest range and reduce until satisfactory reading is obtained.

- 2) If “1” is shown on the LCD, it means the Meter is overloaded, then set the measuring range to higher.
- 3) “ Δ ” means the maximum input current is 200mA, overload will cause the burn of fuse. 10A range has 10A/250V fuse protection

C-4 Measuring AC Current

- 1) Press down $\overline{\sim}$ / \sim button to display “AC” on LCD. If $\sim + \overline{\sim}$ / \sim button has not been pressed down, it means the measuring value is the sum of Direct and Alternate Current ($\overline{\sim} + \sim$). While $\sim + \overline{\sim}$ / \sim has been pressed down, it means the measuring value is a pure alternate current effective value.(TRMS)
- 2) Connect the black test lead to “COM” jack. When measuring 200mA or below, connect the red test lead to “mA” jack. When measuring 10A or below, connect the red test lead to “10A” jack.
- 3) Set the rotary switch to “A \sim ”
- 4) Connect the test leads in series with the object to be measured.

Caution

- 1) Please refer to “DC Current Caution” 1, 2, 3.
- 2) The input value should be 10% more than the selected ranges to fulfill the accuracy requirement.

C-5 Measuring Resistance

- 1) Connect the black test lead to “COM” jack and red test lead “ Ω ” jack.
- 2) Set rotary switch to “ Ω ”
- 3) Connect the test leads across with the object to be measured.

Caution

- 1) If “1” is shown on the LCD, which means the Meter is overloaded, then set a higher measuring range. If resistance is above $1M\Omega$, the reading will only be steady in few seconds which is normal for measuring higher value of resistance
- 2) “1” is displayed when open circuit or no input.
- 3) Make sure all objects, circuit and components to be measured are without voltage and discharge all high-voltage capacitors.

C-6 Measuring Capacitance

- 1) Input the being measured capacitor to the capacitance jack (not require test lead)
- 2) Before measuring capacitance, remember it takes time for zeroing when changing ranges. Floating reading does not effect accuracy.

Caution

- 1) To avoid damage of the Meter or the equipment under test, disconnect circuit powers and discharge all high-voltage capacitors before measuring capacitance.
- 2) Input capacitor to the capacitance jack.
- 3) Stabilizing reading takes time when measuring high capacitance
- 4) Unit: $1pF=10^{-6}\mu F$, $1nF = 10^{-3}\mu F$

C-7 Measuring Frequency

- 1) Connect red test lead to “Hz” jack and black test lead to “COM” jack.
- 2) Set the rotary switch to “kHz”
- 3) Connect the test leads across with the object being measured. LCD appears the frequency value.

Caution

When measuring above 30Vrms, accuracy could not be guaranteed and take extra care of safety as voltage brings dangerous electricity .

C-8 Measuring Diode and Continuity beeper

- 1) Connect the black test lead to “COM” jack and red test lead to “V Ω ” jack (Red test lead polarity is "+")
- 2) Set the rotary switch to “ ”
- 3) Connect the test lead across with the object being measured. The reading is Diode Forward Voltage Drop Nearest Value.
- 4) Connect the test lead to object’s two points being measured, the beeper sounds if the resistant value between the two points is below 30 Ω .

C-9 DATA-Hold

- 1) Press DATA-H to enter and exit the hold mode
- 2) It is not necessarily to connect the test lead.

C-10 Auto-Power Off function

- 1) The Meter equips with auto-power off function. It will be in a sleep mode when it has been operated for 30 minutes. Power will be automatically cut off.
- 2) Press the on/off switch two times to power up again.

D Maintenance

 The Meter is a highly precise electrical testing instrument, do not attempt to change the circuit of your Meter. Take a note of the following few points:

- 1) Do not connect to DC Voltage above 1000V or AC Effective Value Voltage above 750V
- 2) Do not input voltage when the rotary switch is in "Current Range", " Ω ", " \rightarrow \bullet) "
- 3) Do not operate the Meter if battery is not inside the Meter or bottom cabinet is not securely screwed.
- 4) Disconnect the test leads and power off the Meter before replacing the Battery and Fuses.

E. Accessories

- 1) A book of users manual
- 2) A pair of test lead
- 3) A piece of holster (if selected)

F. Using Holster

Three different ways to use holster:

- 1) Set holster parallel on the table, do not open the tilt stand (see diagram 1)
- 2) Set holster in a small angle on the table, tilt it up by the first part of tilt stand (see diagram 2)
- 3) Set holster in a large angle on the table, tilt it up by all two parts of tilt stand (see diagram 2).

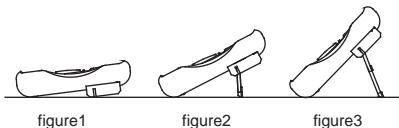

G. Using Strap

- 1) Put the front end of the strap through the round metal of the Meter, see diagram 1.
- 2) Put the bottom end of the strap through the front part and tie it up, see diagram 2.

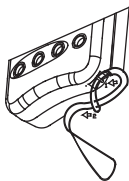

~ END ~

* The manual is subject to changes without separate notice. *

UNI-T[®]

Model UT57: OPERATING MANUAL

Manufacturer: UNI-TREND TECHNOLOGY(DONG GUAN)LIMITED
Address: Dong Fang Da Dao, Bei Shan Dong Fang Industrial
Development District, Hu Men Town, Dong Guan City,
Guang Dong Province, China

Headquarters: Uni-Trend International Limited
Address: Rm901, 9/F, Nanyang Plaza 57 Hung To Road
Kwun Tong Kowloon, Hong Kong

Tel: (852) 2950 9168
Fax: (852) 2950 9303
Email: info@uni-trend.com
<http://www.uni-trend.com>